

# Axis-Q

## Axial wall fans

### Use

- Supply and extract ventilation systems installed in various premises.
- Ideal solution for boosting large air volumes at low aerodynamic resistance in the ventilation system.
- Refrigerating technologies for cooling of compressor condensing units.
- Direct air extract.
- For positive pressure ventilation in fire-fighting systems.



**Air flow:**  
up to 25 000 m<sup>3</sup>/h  
6945 l/s



**Power:**  
from 50 W



**Noise level:**  
from 38 dBA



### Design

- Steel casing and impeller with a special polymer atmospheric resistant coating.
- Casing is equipped with a square mounting plate and a round flange to facilitate wall mounting.
- The fan is equipped with a terminal box for connection to power mains.

### Motor

- Two-, four-, six- or eight-pole asynchronous motor with external rotor and axial impeller.
- Single-phase (E) or three-phase (D) motor modifications.
- Equipped with ball bearings for longer service life.
- Integrated overheating protection with automatic restart.

### Speed control

- Smooth speed control with an external thyristor controller or step speed control with an external auto transformer (both available upon separate order).



### Mounting

- Wall surface mounting with a square connecting frame.
- Any mounting position with respect to air flow direction in the system.
- Power is supplied through an external terminal box.

### Designation key

Series	Dimension type	Motor Number of poles	Phase
Axis-Q	200; 250; 300; 350; 400; 450; 500; 550; 630; 710; 800	2; 4; 6; 8	E: single-phase D: three-phase

### Accessories

Flexible antivibration connector	Speed controller
 EVAF	 CDT E1.8

**Overall dimensions [mm]**

Type	Ø D	Ø d	B	B1	L	Weight [kg]
Axis-Q 200 2E	210	7	312	260	125	3.0
Axis-Q 250 2E	260	7	370	320	135	4.0
Axis-Q 250 4E	260	7	370	320	135	3.5
Axis-Q 300 2E	317	9	430	380	145	6.1
Axis-Q 300 4E	317	9	430	380	145	5.0
Axis-Q 350 4E	374	9	485	435	165	7.8
Axis-Q 400 4E	416	9	540	490	220	8.8
Axis-Q 450 4E	465	11	576	535	230	10.5
Axis-Q 450 6E	465	11	576	535	230	10.5
Axis-Q 500 4E	520	11	655	615	250	14.0
Axis-Q 500 6E	520	11	655	615	250	14.0
Axis-Q 550 4E	570	11	725	675	260	16.5
Axis-Q 550 6E	570	11	725	675	260	16.5
Axis-Q 630 4E	650	11	800	710	275	20.0
Axis-Q 630 6E	650	11	800	710	275	20.0
Axis-Q 250 2D	260	7	370	320	135	4.0
Axis-Q 250 4D	260	7	370	320	135	3.5
Axis-Q 300 2D	317	9	430	380	145	5.4
Axis-Q 300 4D	317	9	430	380	145	5.4
Axis-Q 350 4D	374	9	485	435	165	7.8
Axis-Q 400 4D	416	9	540	490	220	8.8
Axis-Q 450 4D	465	11	576	535	230	10.5
Axis-Q 450 6D	465	11	576	535	230	10.5
Axis-Q 500 4D	520	11	655	615	250	14.0
Axis-Q 500 6D	520	11	655	615	250	14.0
Axis-Q 550 4D	570	11	725	675	260	16.5
Axis-Q 550 6D	570	11	725	675	260	16.5
Axis-Q 630 4D	650	11	800	710	275	20.0
Axis-Q 630 6D	650	11	800	710	275	20.0
Axis-Q 710 6D	725	13	900	810	350	33.0
Axis-Q 710 8D	725	13	900	810	350	33.0
Axis-Q 800 6D	800	13	970	910	350	44.0
Axis-Q 800 8D	800	13	970	910	350	44.0

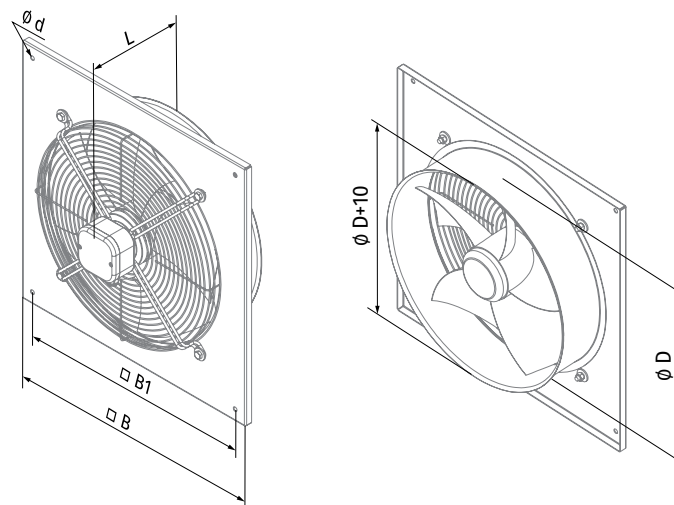

**Technical data**

Parameters	Axis-Q 200 2E	Axis-Q 250 2E	Axis-Q 250 4E	Axis-Q 300 2E	Axis-Q 300 4E	Axis-Q 350 4E	Axis-Q 400 4E	
Voltage [V]	1 ~ 230		1 ~ 230		1 ~ 230		1 ~ 230	
Frequency [Hz]	50 60	50 60	50 60	50 60	50 60	50 60	50 60	
Power [W]	55 61	80 91	50 56	145 178	75 92	140 147	180 240	
Current [A]	0.26 0.28	0.4 0.42	0.22 0.24	0.66 0.79	0.35 0.4	0.65 0.66	0.82 1.08	
Maximum air flow [m³/h (l/s)]	860 (239)	875 (243)	1050 (292)	1150 (319)	800 (222)	865 (240)	2230 (619)	
RPM [min <sup>-1</sup> ]	2300 2550	2400 2990	1380 1730	2300 2410	1350 1405	1380 1700	1380 1655	
Sound pressure at 3 m [dBA]	48 49	50 51	38 39	53 54	44 45	46 47	53 54	
Transported air temperature [°C]	-30...+60 -30...+50		-30...+60 -30...+50		-30...+60 -30...+50		-30...+60 -30...+50	
IP rating	IPX4		IPX4		IPX4		IPX4	
Motor IP rating	IP24		IP24		IP24		IP24	

**AXIS-Q 200 2E**

Sound power level, A-weighted	Octave frequency bands [Hz]								LpA 3 m [dBA]	LpA 1 m [dBA]	
	Total	63	125	250	500	1000	2000	4000			8000
LWA to environment [dBA]	68	28	39	52	58	66	62	57	50	48	58

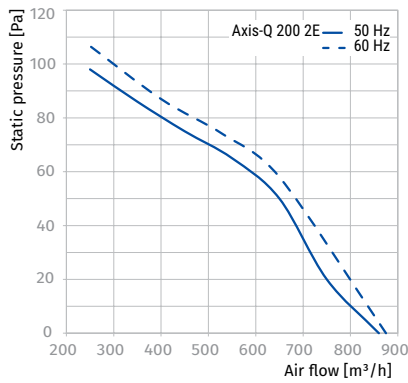
**AXIS-Q 250 2E, AXIS-Q 250 4E**

Sound power level, A-weighted	Octave frequency bands [Hz]								LpA 3 m [dBA]	LpA 1 m [dBA]
	Total	63	125	250	500	1000	2000	4000		

**Axis-Q 250 2E**

LWA to environment [dBA]	70	29	40	54	60	68	64	59	52	50	60
--------------------------	----	----	----	----	----	----	----	----	----	----	----

**Axis-Q 250 4E**

LWA to environment [dBA]	59	25	39	43	49	54	54	49	43	38	48
--------------------------	----	----	----	----	----	----	----	----	----	----	----

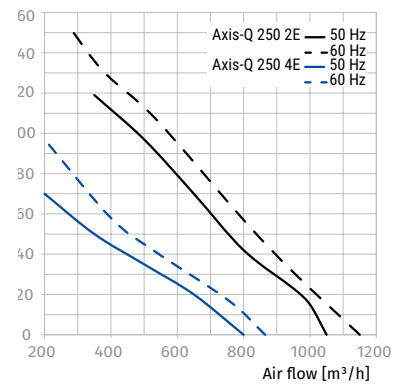
**AXIS-Q 300 2E, AXIS-Q 300 4E**

Sound power level, A-weighted	Octave frequency bands [Hz]								LpA 3 m [dBA]	LpA 1 m [dBA]
	Total	63	125	250	500	1000	2000	4000		

**Axis-Q 300 2E**

LWA to environment [dBA]	74	40	49	63	63	71	67	60	56	53	63
--------------------------	----	----	----	----	----	----	----	----	----	----	----

**Axis-Q 300 4E**

LWA to environment [dBA]	64	41	52	47	54	60	60	52	44	44	54
--------------------------	----	----	----	----	----	----	----	----	----	----	----

**AXIS-Q 300 2E**

η, (%)	MC	EC	N	VSD	[kW]	(A)	[m³/h]	[Pa]	[RPM]	SR
30.5	A	Static	42.2	No	0.141	0.64	1380	110	2350	1

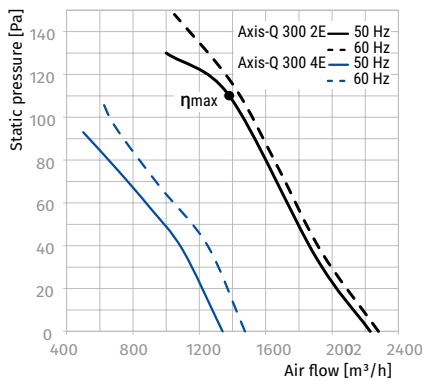
**AXIS-Q 350 4E, AXIS-Q 400 4E**

Sound power level, A-weighted	Octave frequency bands [Hz]								LpA 3 m [dBA]	LpA 1 m [dBA]
	Total	63	125	250	500	1000	2000	4000		

**Axis-Q 350 4E**

LWA to environment [dBA]	67	26	43	49	60	62	62	53	46	46	56
--------------------------	----	----	----	----	----	----	----	----	----	----	----

**Axis-Q 400 4E**

LWA to environment [dBA]	73	46	52	58	65	68	68	65	57	53	63
--------------------------	----	----	----	----	----	----	----	----	----	----	----

**AXIS-Q 350 4E**

η, (%)	MC	EC	N	VSD	[kW]	(A)	[m³/h]	[Pa]	[RPM]	SR
29.9	A	Static	41.8	No	0.130	0.6	1717	80	1375	1

**AXIS-Q 400 4E**

η, (%)	MC	EC	N	VSD	[kW]	(A)	[m³/h]	[Pa]	[RPM]	SR
33.8	A	Static	44.8	No	0.187	0.86	2787	80	1355	1

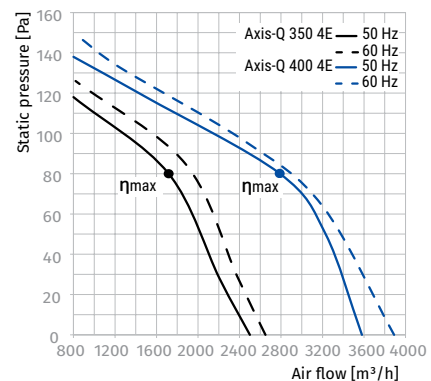

Parameters	Axis-Q 450 4E		Axis-Q 450 6E		Axis-Q 500 4E		Axis-Q 500 6E	
Voltage [V]	1 ~ 230		1 ~ 230		1 ~ 230		1 ~ 230	
Frequency [Hz]	50	60	50	60	50	60	50	60
Power [W]	250	325	151	161	420	455	220	268
Current [A]	1.2	1.46	0.78	0.8	1.95	2.05	1.1	1.22
Maximum air flow [m³/h (l/s)]	4680 (1300)	4790 (1331)	3200 (889)	3250 (903)	7060 (1961)	7130 (1981)	4880 (1356)	5380 (1495)
RPM [min⁻¹]	1350	1600	945	1115	1300	1630	945	1105
Sound pressure at 3 m [dBA]	56	57	52	52	58	59	56	56
Transported air temperature [°C]	-30...+60	-30...+50	-30...+60	-30...+50	-30...+60	-30...+50	-30...+60	-30...+50
IP rating	IPX4		IPX4		IPX4		IPX4	
Motor IP rating	IP24		IP24		IP24		IP24	

**AXIS-Q 450 4E, AXIS-Q 450 6E**

Sound power level, A-weighted	Octave frequency bands [Hz]								LpA 3 m [dBA]	LpA 1 m [dBA]	
	Total	63	125	250	500	1000	2000	4000			8000
<b>Axis-Q 450 4E</b>											
LWA to environment [dBA]	76	46	57	64	70	72	70	66	58	56	66
<b>Axis-Q 450 6E</b>											
LWA to environment [dBA]	72	45	51	57	64	67	67	64	56	52	62

**AXIS-Q 450 4E**

η, (%)	MC	EC	N	VSD	[kW]	(A)	[m³/h]	[Pa]	[RPM]	SR
32.0	A	Static	41.8	No	0.288	1.31	3610	90	1270	1

**AXIS-Q 450 6E**

η, (%)	MC	EC	N	VSD	[kW]	(A)	[m³/h]	[Pa]	[RPM]	SR
28.3	A	Static	37.2	No	0.139	0.7	1733	72	910	1

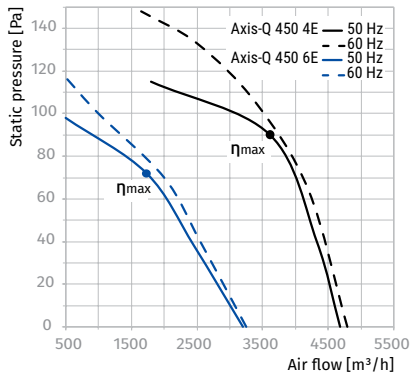

**AXIS-Q 500 4E, AXIS-Q 500 6E**

Sound power level, A-weighted	Octave frequency bands [Hz]								LpA 3 m [dBA]	LpA 1 m [dBA]	
	Total	63	125	250	500	1000	2000	4000			8000
<b>Axis-Q 500 4E</b>											
LWA to environment [dBA]	79	49	60	67	73	74	73	68	60	58	68
<b>Axis-Q 500 6E</b>											
LWA to environment [dBA]	76	46	58	64	70	72	70	66	59	56	66

**AXIS-Q 500 4E**

η, (%)	MC	EC	N	VSD	[kW]	(A)	[m³/h]	[Pa]	[RPM]	SR
32.1	A	Static	40.7	No	0.440	2.01	4987	100	1285	1

**AXIS-Q 500 6E**

η, (%)	MC	EC	N	VSD	[kW]	(A)	[m³/h]	[Pa]	[RPM]	SR
30.1	A	Static	41.1	No	0.186	0.86	3288	60	900	1

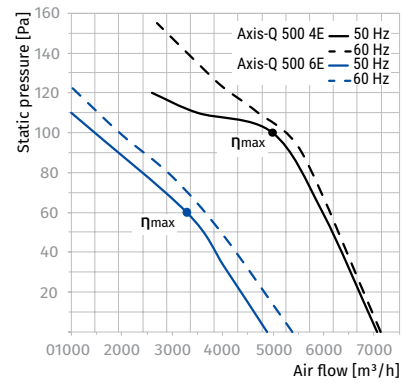

Parameters	Axis-Q 550 4E		Axis-Q 550 6E		Axis-Q 630 4E		Axis-Q 630 6E	
Voltage [V]	1 ~ 230		1 ~ 230		1 ~ 230		1 ~ 230	
Frequency [Hz]	50	60	50	60	50	60	50	60
Power [W]	550	654	330	375	750	979	540	610
Current [A]	2.55	2.88	1.6	1.63	3.5	4.26	2.4	2.74
Maximum air flow [m <sup>3</sup> /h (l/s)]	8800 (2445)	8970 (2492)	6400 (1778)	6520 (1811)	11900 (3306)	12100 (3361)	10900 (3028)	10990 (3053)
RPM [min <sup>-1</sup> ]	1300	1580	950	1060	1360	1625	850	1075
Sound pressure at 3 m [dBA]	62	63	58	58	67	68	59	59
Transported air temperature [°C]	-30...+60	-30...+50	-30...+60	-30...+50	-30...+60	-30...+50	-30...+60	-30...+50
IP rating	IPX4		IPX4		IPX4		IPX4	
Motor IP rating	IP24		IP24		IP24		IP24	

**AXIS-Q 550 4E, AXIS-Q 550 6E**

Sound power level, A-weighted	Octave frequency bands [Hz]								LpA 3 m [dBA]	LpA 1 m [dBA]	
	Total	63	125	250	500	1000	2000	4000			8000
<b>Axis-Q 550 4E</b>											
LWA to environment [dBA]	83	52	64	71	77	78	77	72	64	62	72
<b>Axis-Q 550 6E</b>											
LWA to environment [dBA]	79	50	61	68	72	73	74	69	60	58	68

**AXIS-Q 550 4E**

η, (%)	MC	EC	N	VSD	[kW]	(A)	[m <sup>3</sup> /h]	[Pa]	[RPM]	SR
34.7	A	Static	42.6	No	0.581	2.64	5919	120	1240	1

**AXIS-Q 550 6E**

η, (%)	MC	EC	N	VSD	[kW]	(A)	[m <sup>3</sup> /h]	[Pa]	[RPM]	SR
33.3	A	Static	43.1	No	0.279	1.34	4087	80	910	1

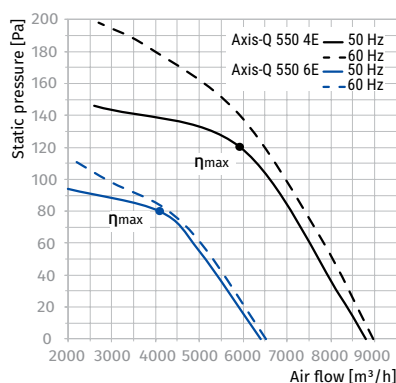
**AXIS-Q 630 4E, AXIS-Q 630 6E**

Sound power level, A-weighted	Octave frequency bands [Hz]								LpA 3 m [dBA]	LpA 1 m [dBA]	
	Total	63	125	250	500	1000	2000	4000			8000
<b>Axis-Q 630 4E</b>											
LWA to environment [dBA]	88	57	68	76	81	83	82	77	69	67	77
<b>Axis-Q 630 6E</b>											
LWA to environment [dBA]	80	51	62	69	74	75	73	67	59	59	69

**AXIS-Q 630 4E**

η, (%)	MC	EC	N	VSD	[kW]	(A)	[m <sup>3</sup> /h]	[Pa]	[RPM]	SR
37.5	A	Static	44.4	No	0.800	3.76	7095	149	1290	1

**AXIS-Q 630 6E**

η, (%)	MC	EC	N	VSD	[kW]	(A)	[m <sup>3</sup> /h]	[Pa]	[RPM]	SR
35	A	Static	43.3	No	0.500	2.55	6857	90	915	1

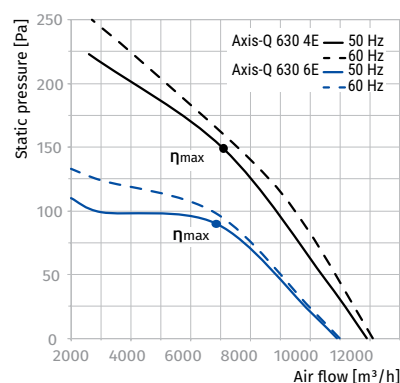

Parameters	Axis-Q 250 2D		Axis-Q 250 4D		Axis-Q 300 2D		Axis-Q 300 4D	
Voltage [V]	3 ~ 400		3 ~ 400		3 ~ 400		3 ~ 400	
Frequency [Hz]	50	60	50	60	50	60	50	60
Power [W]	80	92	60	89	145	165	75	94
Current [A]	0.22	0.24	0.17	0.22	0.25	0.29	0.22	0.25
Maximum air flow [m³/h (l/s)]	1060 (294)	1150 (319)	850 (236)	885 (246)	2310 (642)	2390 (664)	1310 (364)	1530 (425)
RPM [min⁻¹]	2600	3030	1400	1750	2350	2570	1380	1640
Sound pressure at 3 m [dBA]	51	52	38	38	52	52	45	45
Transported air temperature [°C]	-30...+60	-30...+50	-30...+60	-30...+50	-30...+60	-30...+50	-30...+60	-30...+50
IP rating	IPX4		IPX4		IPX4		IPX4	
Motor IP rating	IP44		IP44		IP44		IP44	

**AXIS-Q 250 2D, AXIS-Q 250 4D**

Sound power level, A-weighted	Octave frequency bands [Hz]								LpA 3 m [dBA]	LpA 1 m [dBA]	
	Total	63	125	250	500	1000	2000	4000			8000
<b>Axis-Q 250 2D</b>											
LWA to environment [dBA]	71	29	41	55	61	69	65	60	52	51	61
<b>Axis-Q 250 4D</b>											
LWA to environment [dBA]	59	25	39	43	49	54	54	49	43	38	48

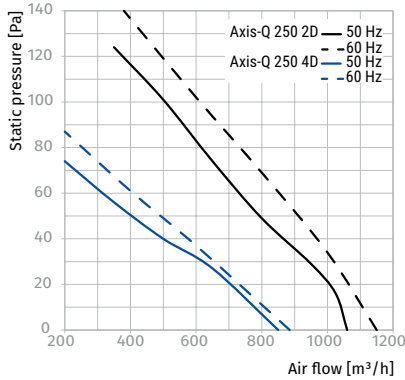

**AXIS-Q 300 2D, AXIS-Q 300 4D**

Sound power level, A-weighted	Octave frequency bands [Hz]								LpA 3 m [dBA]	LpA 1 m [dBA]	
	Total	63	125	250	500	1000	2000	4000			8000
<b>Axis-Q 300 2D</b>											
LWA to environment [dBA]	73	39	48	62	62	70	66	60	55	52	62
<b>Axis-Q 300 4D</b>											
LWA to environment [dBA]	65	42	53	46	55	61	61	53	44	45	55

**AXIS-Q 300 2D**

η, (%)	MC	EC	N	VSD	[kW]	(A)	[m³/h]	[Pa]	[RPM]	SR
30.3	A	Static	42	No	0.141	0.25	1367	110	2350	1

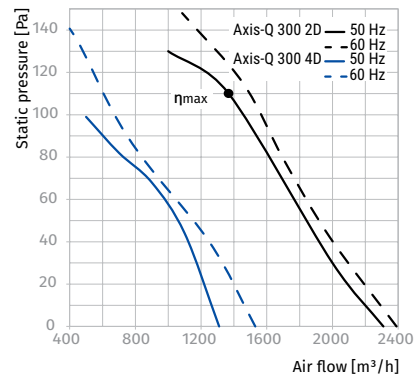

Parameters	Axis-Q 350 4D		Axis-Q 400 4D		Axis-Q 450 4D		Axis-Q 450 6D	
Voltage [V]	3 ~ 400		3 ~ 400		3 ~ 400		3 ~ 400	
Frequency [Hz]	50	60	50	60	50	60	50	60
Power [W]	140	150	180	195	250	275	148	175
Current [A]	0.38	0.41	0.47	0.55	0.6	0.65	0.42	0.47
Maximum air flow [m³/h (l/s)]	2520 (700)	2590 (720)	3740 (1039)	3870 (1075)	5280 (1467)	5350 (1486)	3500 (972)	3580 (995)
RPM [min⁻¹]	1380	1640	1380	1625	1360	1620	900	1050
Sound pressure at 3 m [dBA]	46	46	54	54	56	56	53	53
Transported air temperature [°C]	-30...+60	-30...+50	-30...+60	-30...+50	-30...+60	-30...+50	-30...+60	-30...+50
IP rating	IPX4		IPX4		IPX4		IPX4	
Motor IP rating	IP44		IP44		IP44		IP24	

**AXIS-Q 350 4D, AXIS-Q 400 4D**

Sound power level, A-weighted	Octave frequency bands [Hz]								LpA 3 m [dBA]	LpA 1 m [dBA]	
	Total	63	125	250	500	1000	2000	4000			8000
<b>Axis-Q 350 4D</b>											
LWA to environment [dBA]	66	26	43	48	59	62	62	53	46	46	56
<b>Axis-Q 400 4D</b>											
LWA to environment [dBA]	74	31	48	58	63	70	70	66	58	54	64

**AXIS-Q 350 4D**

η, (%)	MC	EC	N	VSD	[kW]	(A)	[m³/h]	[Pa]	[RPM]	SR
31.7	A	Static	43.7	No	0.129	0.37	1802	80	1400	1

**AXIS-Q 400 4D**

η, (%)	MC	EC	N	VSD	[kW]	(A)	[m³/h]	[Pa]	[RPM]	SR
34.3	A	Static	44.9	No	0.209	0.47	2807	90	1365	1

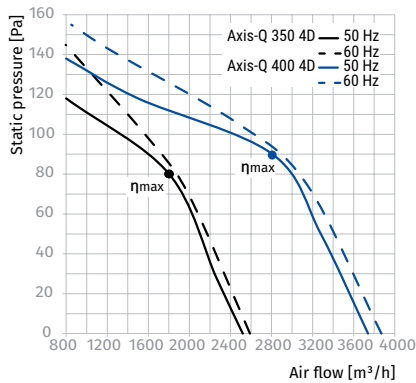

**AXIS-Q 450 4D, AXIS-Q 450 6D**

Sound power level, A-weighted	Octave frequency bands [Hz]								LpA 3 m [dBA]	LpA 1 m [dBA]	
	Total	63	125	250	500	1000	2000	4000			8000
<b>Axis-Q 450 4D</b>											
LWA to environment [dBA]	77	48	60	67	70	71	72	67	59	56	66
<b>Axis-Q 450 6D</b>											
LWA to environment [dBA]	73	44	55	61	67	69	67	63	56	53	63

**AXIS-Q 450 4D**

η, (%)	MC	EC	N	VSD	[kW]	(A)	[m³/h]	[Pa]	[RPM]	SR
35.1	A	Static	44.8	No	0.296	0.59	3659	100	1310	1

**AXIS-Q 450 6D**

η, (%)	MC	EC	N	VSD	[kW]	(A)	[m³/h]	[Pa]	[RPM]	SR
28.4	A	Static	37.9	No	0.145	0.4	1790	75	900	1

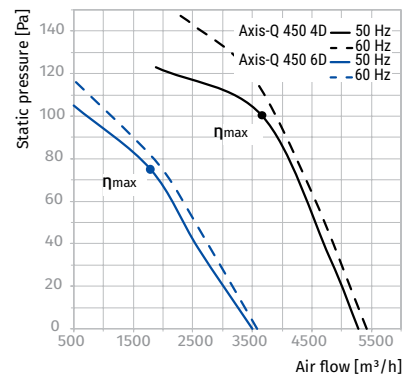

Parameters	Axis-Q 500 4D		Axis-Q 500 6D		Axis-Q 550 4D		Axis-Q 550 6D	
Voltage [V]	3 ~ 400		3 ~ 400		3 ~ 400		3 ~ 400	
Frequency [Hz]	50	60	50	60	50	60	50	60
Power [W]	450	370	230	281	750	600	337	447
Current [A]	0.9	0.7	0.58	0.59	1.5	1.1	0.9	0.95
Maximum air flow [m³/h (l/s)]	6570 (1825)	6230 (1731)	4900 (1361)	5430 (1508)	9700 (2695)	7380 (2050)	6400 (1778)	6520 (1811)
RPM [min⁻¹]	1300	1605	920	1015	1350	1605	910	1020
Sound pressure at 3 m [dBA]	60	60	57	57	64	64	61	61
Transported air temperature [°C]	-30...+60	-30...+50	-30...+60	-30...+50	-30...+60	-30...+50	-30...+60	-30...+50
IP rating	IPX4		IPX4		IPX4		IPX4	
Motor IP rating	IP24		IP24		IP24		IP24	

**AXIS-Q 500 4D, AXIS-Q 500 6D**

Sound power level, A-weighted	Octave frequency bands [Hz]								LpA 3 m [dBA]	LpA 1 m [dBA]	
	Total	63	125	250	500	1000	2000	4000			8000
<b>Axis-Q 500 4D</b>											
LWA to environment [dBA]	81	51	63	70	74	75	76	71	62	60	70
<b>Axis-Q 500 6D</b>											
LWA to environment [dBA]	78	48	59	66	72	73	72	67	59	57	67

**AXIS-Q 500 4D**

η, (%)	MC	EC	N	VSD	[kW]	(A)	[m³/h]	[Pa]	[RPM]	SR
35.5	A	Static	43.9	No	0.478	0.9	4988	120	1305	1

**AXIS-Q 500 6D**

η, (%)	MC	EC	N	VSD	[kW]	(A)	[m³/h]	[Pa]	[RPM]	SR
30.5	A	Static	41.5	No	0.185	0.47	3308	60	915	1

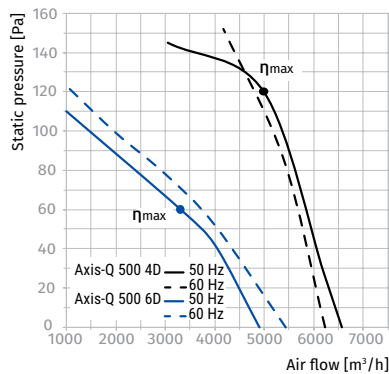

**AXIS-Q 550 4D, AXIS-Q 550 6D**

Sound power level, A-weighted	Octave frequency bands [Hz]								LpA 3 m [dBA]	LpA 1 m [dBA]	
	Total	63	125	250	500	1000	2000	4000			8000
<b>Axis-Q 550 4D</b>											
LWA to environment [dBA]	85	53	65	72	79	80	79	73	65	64	74
<b>Axis-Q 550 6D</b>											
LWA to environment [dBA]	82	51	63	70	76	77	76	71	63	61	71

**AXIS-Q 550 4D**

η, (%)	MC	EC	N	VSD	[kW]	(A)	[m³/h]	[Pa]	[RPM]	SR
38.8	A	Static	46.3	No	0.656	1.27	6400	140	1175	1

**AXIS-Q 550 6D**

η, (%)	MC	EC	N	VSD	[kW]	(A)	[m³/h]	[Pa]	[RPM]	SR
34.4	A	Static	44.3	No	0.273	0.74	4142	80	920	1

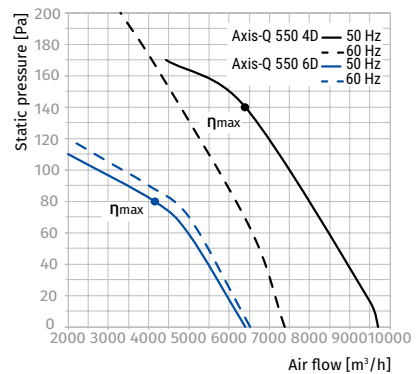



Parameters	Axis-Q 630 4D		Axis-Q 630 6D		Axis-Q 710 6D	Axis-Q 710 8D
Voltage [V]	3 ~ 400		3 ~ 400		3 ~ 400	3 ~ 400
Frequency [Hz]	50	60	50	60	50	50
Power [W]	800	910	550	716	1150	700
Current [A]	1.6	1.68	1.45	1.56	2.0	1.5
Maximum air flow [m³/h (l/s)]	12200 (3389)	12400 (3445)	10950 (3042)	11120 (3089)	15440 (4289)	12000 (3334)
RPM [min <sup>-1</sup> ]	1320	1585	900	1060	830	710
Sound pressure at 3 m [dBA]	69	69	59	59	63	61
Transported air temperature [°C]	-30...+60	-30...+50	-30...+60	-30...+50	-30...+60	-30...+60
IP rating	IPX4		IPX4		IPX4	IPX4
Motor IP rating	IP24		IP24		IP44	IP44

**AXIS-Q 630 4D, AXIS-Q 630 6D**

Sound power level, A-weighted	Octave frequency bands [Hz]								LpA 3 m [dBA]	LpA 1 m [dBA]	
	Total	63	125	250	500	1000	2000	4000			8000
<b>Axis-Q 630 4D</b>											
LWA to environment [dBA]	90	58	69	78	83	85	84	79	70	69	79
<b>Axis-Q 630 6D</b>											
LWA to environment [dBA]	80	51	61	69	73	75	74	70	62	59	69

**AXIS-Q 630 4D**

η, (%)	MC	EC	N	VSD	[kW]	(A)	[m³/h]	[Pa]	[RPM]	SR
41.2	A	Static	48.1	No	0.810	1.61	7743	152	1290	1

**AXIS-Q 630 6D**

η, (%)	MC	EC	N	VSD	[kW]	(A)	[m³/h]	[Pa]	[RPM]	SR
37.0	A	Static	45.2	No	0.515	1.33	6737	100	920	1

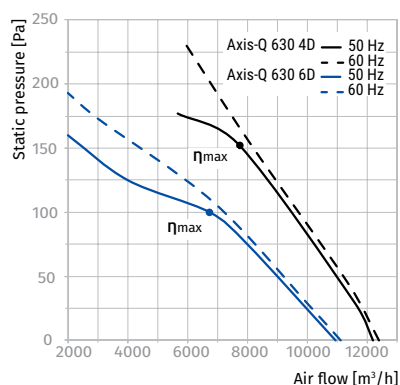
**AXIS-Q 710 6D, AXIS-Q 710 8D**

Sound power level, A-weighted	Octave frequency bands [Hz]								LpA 3 m [dBA]	LpA 1 m [dBA]	
	Total	63	125	250	500	1000	2000	4000			8000
<b>Axis-Q 710 6D</b>											
LWA to environment [dBA]	83	54	65	72	78	79	77	70	62	63	73
<b>Axis-Q 710 8D</b>											
LWA to environment [dBA]	82	53	64	71	76	77	75	69	61	61	71

**AXIS-Q 710 6D**

η, (%)	MC	EC	N	VSD	[kW]	(A)	[m³/h]	[Pa]	[RPM]	SR
35.6	A	Static	42	No	0.979	1.91	8777	140	830	1

**AXIS-Q 710 8D**

η, (%)	MC	EC	N	VSD	[kW]	(A)	[m³/h]	[Pa]	[RPM]	SR
29.4	A	Static	37	No	0.648	1.48	8110	83	810	1

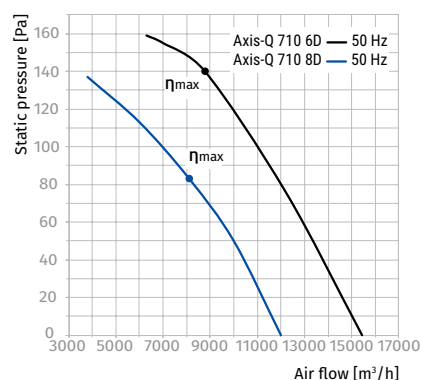

Parameters	Axis-Q 800 6D	Axis-Q 800 8D
Voltage [V]	3 ~ 400	3 ~ 400
Frequency [Hz]	50	50
Power [W]	1850	700
Current [A]	3.7	1.7
Maximum air flow [m³/h (l/s)]	25000 (6945)	15550 (4320)
RPM [min⁻¹]	915	710
Sound pressure at 3 m [dBA]	67	66
Transported air temperature [°C]	-30...+60	-30...+60
IP rating	IPX4	IPX4
Motor IP rating	IP44	IP44

**AXIS-Q 800 6D, AXIS-Q 800 8D**

Sound power level, A-weighted	Octave frequency bands [Hz]									LpA 3 m [dBA]	LpA 1 m [dBA]
	Total	63	125	250	500	1000	2000	4000	8000		
<b>Axis-Q 800 6D</b>											
LWA to environment [dBA]	88	57	69	77	82	83	81	74	65	67	77
<b>Axis-Q 710 8D</b>											
LWA to environment [dBA]	87	56	68	76	81	83	80	74	65	66	76

**AXIS-Q 800 6D**

$\eta_r$ (%)	MC	EC	N	VSD	[kW]	(A)	[m³/h]	[Pa]	[RPM]	SR
31.6	A	Static	36.6	No	1.650	3.6	17040	108	915	1

**AXIS-Q 800 8D**

$\eta_r$ (%)	MC	EC	N	VSD	[kW]	(A)	[m³/h]	[Pa]	[RPM]	SR
32.2	A	Static	39.5	No	0.695	1.7	10955	72	710	1

